

# **BASE RACK** FITTING INSTRUCTION

Part Number: 1780260

Product Description: Awning Mount Quick Release

## **WARNING**

- ◆ This awning mount is designed for awnings up to 16kg in weight, heavier awnings will require additional mounting points
- ◆ Do not use this product for any product, other than those specified by ARB
- ◆ This kit is designed to suit ARB brand awnings, functionality may be compromised using alternate brands
- ◆ This product must be installed exactly as per these instructions using only the hardware supplied
- ◆ This product or its fixing must not be modified in any way
- ◆ These instructions are correct as at the publication date
- ◆ During installation, it is the duty of the installer to check correct operation/clearances of all components
- ◆ Work safely at all times
- ◆ Unless otherwise instructed, tighten fasteners to specified torque
- ◆ Fastener torques are to be checked at regular intervals

## **ARB 4x4 ACCESSORIES**

Corporate Head Office

[www.arb.com.au](http://www.arb.com.au)

42-44 Garden St  
Kilsyth, Victoria  
AUSTRALIA 3137

Tel: +61 (3) 9761 6622  
Fax: +61 (3) 9761 6807

Australian enquiries  
North & South American enquiries  
Other international enquiries

[sales@arb.com.au](mailto:sales@arb.com.au)  
[sales@arbusa.com](mailto:sales@arbusa.com)  
[exports@arb.com.au](mailto:exports@arb.com.au)

### **REQUIRED TOOLS FOR FITMENT OF PRODUCT:**







13mm Spanner/Wrench

10mm Spanner (for canvas awnings)

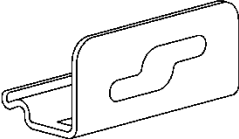
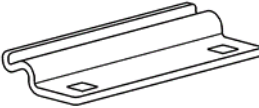
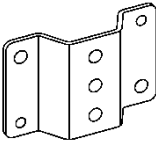
### **FASTENER TORQUE SETTINGS:**

| SIZE | Torque Nm | Torque lbft |
|------|-----------|-------------|
| M6   | 9Nm       | 7lbft       |
| M8   | 22Nm      | 16lbft      |

## PARTS LISTING

| APPLICATION.                                                                        | PART NO. | QTY | DESCRIPTION                |
|-------------------------------------------------------------------------------------|----------|-----|----------------------------|
|    | 3752560  | 2   | BRKT AWNING QR             |
|    | 3752562  | 2   | BRKT ACC CLAMP 100MM       |
|    | 3752614  | 2   | BRKT AWNING MNT STD TXTB   |
|    | 6151921  | 4   | BOLT COHD M8x20 PC8.8 LWHD |
|    | 6151212  | 4   | NUT NYLOC M8 BLACK         |
|   | 4581085  | 4   | WASHER M8x19x1.2mm BLACK   |
|  | 6151869  | 2   | STUD KNURLED M8 X 25       |
|  | 6151655  | 2   | NUT FLANGE M8x1.25 PC8.8   |

## FITTING PROCEDURE

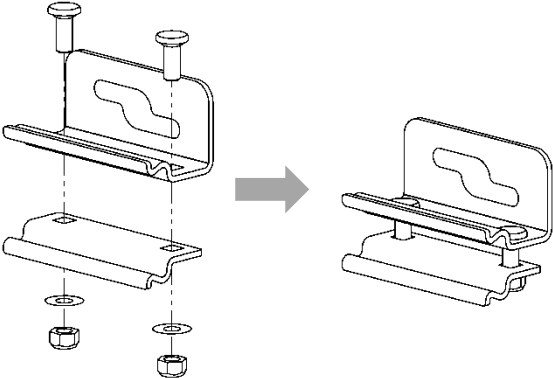
|                                                                                     |                                                                                                                                               |
|-------------------------------------------------------------------------------------|-----------------------------------------------------------------------------------------------------------------------------------------------|
|  | <ol style="list-style-type: none"> <li>Assemble brackets with a pair of M8 bolts, washers and nuts<br/>Only tighten nuts 3-4 turns</li> </ol> |
|-------------------------------------------------------------------------------------|-----------------------------------------------------------------------------------------------------------------------------------------------|

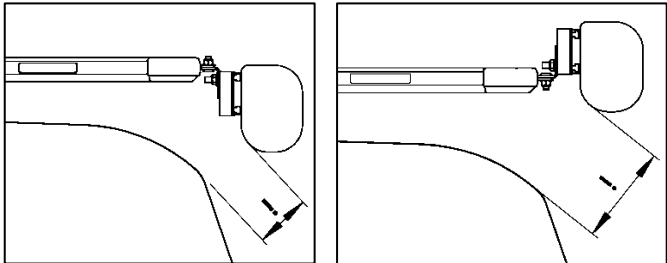
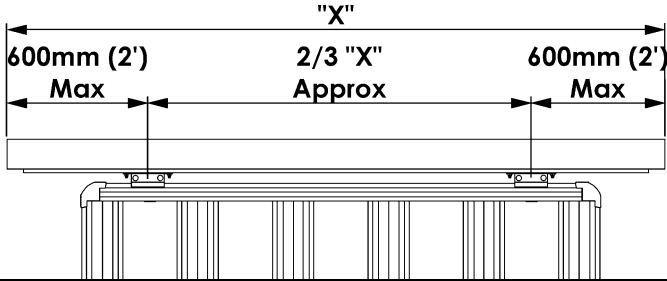
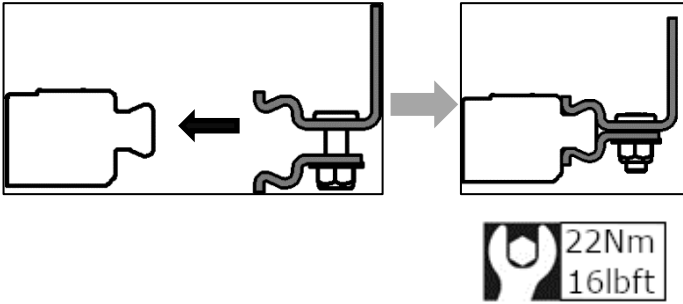
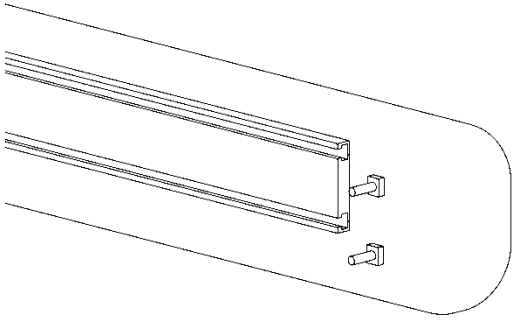
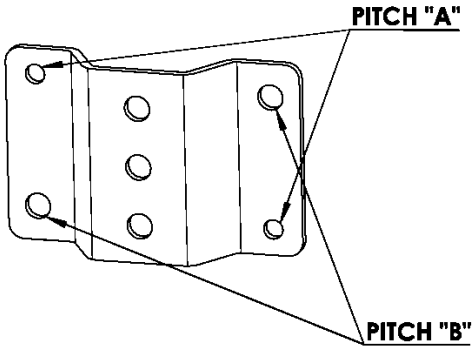
|                                                                                     |                                                                                                                                                                                                                                                                                                                                           |
|-------------------------------------------------------------------------------------|-------------------------------------------------------------------------------------------------------------------------------------------------------------------------------------------------------------------------------------------------------------------------------------------------------------------------------------------|
|    | <p>2. Decide how high the awning will mount</p> <ul style="list-style-type: none"> <li>• The bracket can mount flange up or flange down</li> <li>• The stud can fit in three positions for fine adjustment</li> <li>• Check clearance distance to vehicle panels</li> <li>• Check door opening</li> <li>• Check window opening</li> </ul> |
|    | <p>3. Plan the position of the brackets</p> <ul style="list-style-type: none"> <li>• Distance between brackets greater than 2/3rds the length of the awning</li> <li>• Maximum distance from bracket to awning end 600mm (2')</li> </ul>                                                                                                  |
|   | <p>4. Fit the mounting brackets over the dovetail. Tighten to specified torque</p>                                                                                                                                                                                                                                                        |
|  | <p>5. Insert awning bolts as per awning instructions</p>                                                                                                                                                                                                                                                                                  |
|  | <p>6. There are 2 hole pitches</p> <p>Pitch "A"</p> <ul style="list-style-type: none"> <li>• Suits ARB awnings</li> <li>• 47.5mm pitch</li> <li>• M6 holes</li> </ul> <p>Pitch "B"</p> <ul style="list-style-type: none"> <li>• Suits some alternate brand awnings</li> <li>• 42mm pitch</li> <li>• M8 Holes</li> </ul>                   |

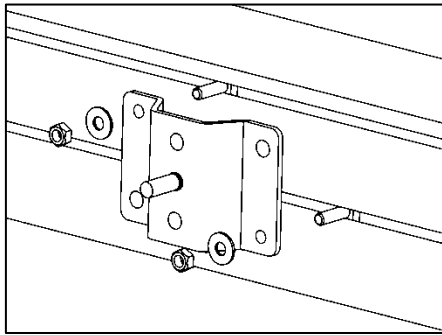

7. Use the awning fasteners to fix the awning brackets to the awning, at the same spacing as step 3.

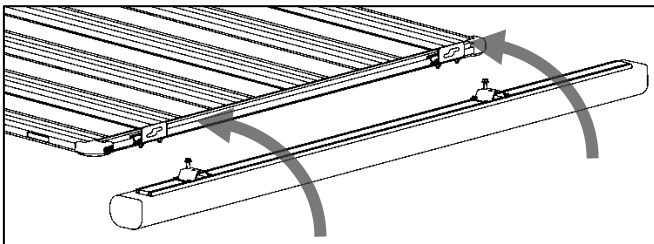
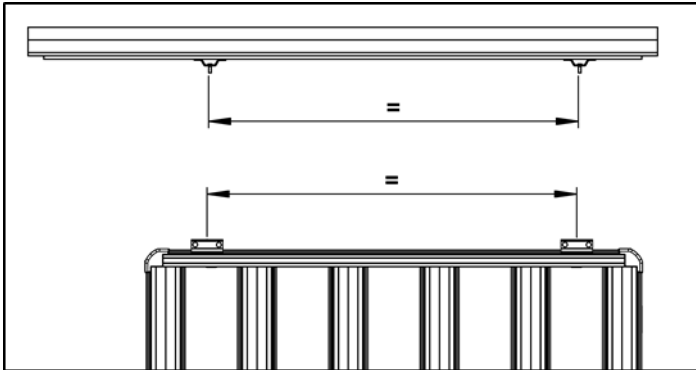

8. Fit the awning by placing the flange nuts and studs through the large hole, slide forward or backward to fully engage

9. Tighten the flange nuts to specified torque

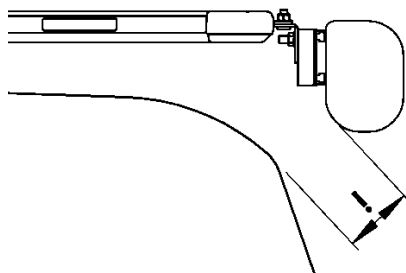
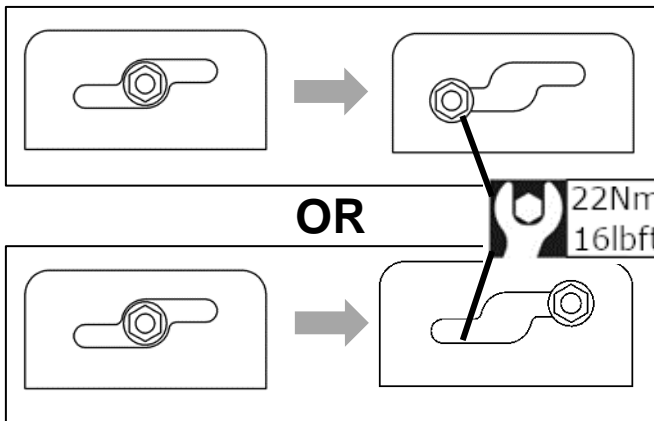

10. Check all clearances

- Check clearance distance to vehicle panels
- Check door opening
- Check window opening on canopies