

# INSTALLATION MANUAL

PRODUCT: FRONT ALUMINUM BUMPER

MODEL: FORD RANGER RAPTOR (2022 - PRESENT)

PART NO: 2D.1813.1-NL



## CAUTION!

To reduce the risk of serious injury or damage to property: Before you start installing and using this product, read the full instructions, pay special attention to the conditions of safe use and recommendations for installation! When installing or maintaining this product, it is necessary to use protective goggles. Check the integrity of the structure and the moment the fastening is tightened every 250 miles (400 kms) of mileage. Do not use this product if there is damage to the structure or fasteners!

## NOTICE

Skid plate is an additional protection, but it can not guarantee to protect against all possible damage in collisions. When driving, be careful of objects and terrain that may damage sensitive parts of the vehicle.

**ADR69 COMPATIBLE**  
**AIR BAG COMPLIANT**

# FRONT BUMPER

---

Part number 2D.1813.1-NL  
Suited to vehicle: FORD RANGER RAPTOR (2022 - PRESENT)  
Material: Aluminum / Steel



## SAFETY NOTICE

---

- \* The RIVAL Bumper is designed to compliment the use and design of the specified vehicle under conditions specified by the vehicle manufacturer.
- \* While driving the vehicle at any speed, collision with any other vehicle, animal or object must always be avoided.
- \* Following any collision with any other vehicle, animal or object, the RIVAL Bumper and the vehicle must be inspected by a specialized or suitably qualified vehicle repairer for possible damage to the components and assemblies in order to confirm suitability for further use of the vehicle.
- \* It is strongly recommended that you do not operate a vehicle with a damaged bumper or its components. In the case of damage, please contact the nearest RIVAL dealer. Vehicle, or where the bumper has been damaged, is extremely dangerous and must be avoided at all cost.
- \* The operation of a vehicle where the bumper is not properly attached and fastened to the vehicle, or where the bumper has been damaged, is extremely dangerous and must be avoided at all cost.
- \* It is recommended that you carry out regular inspections of all the bumper elements such as all bolts, wires, connectors.
- \* A winch with a pull capacity of up to and including 10000 lb can be installed with the RIVAL Bumper. It is not advisable to exceed this pulling capacity since damage, injury or death may occur where the 10000lb recommended capacity is exceeded. The Rival bumper provides standard 4 1/2"x10" mounting holes.

## INSTALLATION NOTICE

---

- \* Personal safety during the installation process must be adhered to at all times.
- \* Estimated time for installation: 4 hours.
- \* The RIVAL Bumper must be mounted and affixed to the vehicle according to this installation manual and the use of personal safety equipment is highly recommended.
- \* Do not install this bumper on vehicle models other than those allowed in this manual.
- \* Check state and local highway safety laws regarding permitted bumper types and heights.

**NOTE:** if the bumper is to be color coded it is advised to test fit before color coding. RIVAL is not liable for color coding cost, it is the installers' responsibility to check the fitment and alignment before color coding.

### **ADR69 AND AIR BAG SYSTEM**

The Rival bumper has been tested and certified to be compatible with ADR69 and will not affect the operation of the Air bag System on this vehicle. This product or mounting brackets must not be modified in any way, and must be fitted in accordance with the installation instructions.

## REQUIRED TOOLS

---

- \* Basic tool kit
- \* Torque wrench
- \* Crosspoint and flat head screwdriver
- \* Marker
- \* Angle grinder
- \* Drill

## TORQUE SETTING

---

- \* M6 - 9 N·m
- \* M8 - 24 N·m
- \* M10 - 30 N·m
- \* M12 - 77 N·m

# TECHNICAL INFORMATION

## RECOVERY POINTS



### **WARNING!**

Do not exceed the Working Load Limit of these recovery points or shackle.

### **INSPECTION AND SAFETY**

Recovery of stuck vehicles can be dangerous. Always inspect the shackle and recovery points before each use. Do not use if there are visible signs of damage or wear including cracking (or elongation). Always stay a safe distance away from the recovery area - at least 1.5 times the length of the recovery strap. Incorrect use of receivers equipment can result in serious injury or death.

Always use recovery points as a matched pair teamed with an equalising bridle during any recovery situation.

Please attach this "Warning" label to the door aperture.

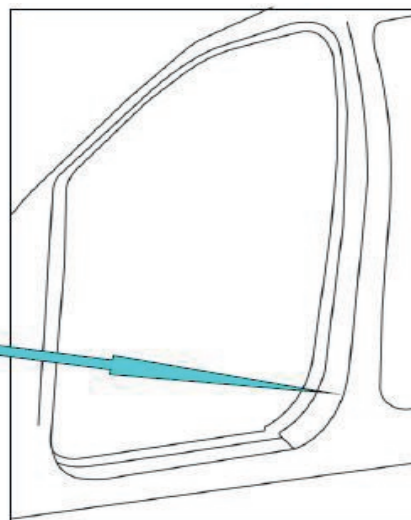
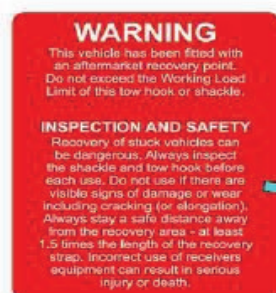

# TECHNICAL INFORMATION

## \*WINCH INSTALLATION

A winch with a pull capacity of up to 10000 lbs can be installed with the RIVAL Bumper. It is not advisable to exceed this pulling capacity since damage, injury or death may occur where the 10000 lbs recommended capacity is exceeded.

### Winch measurements:

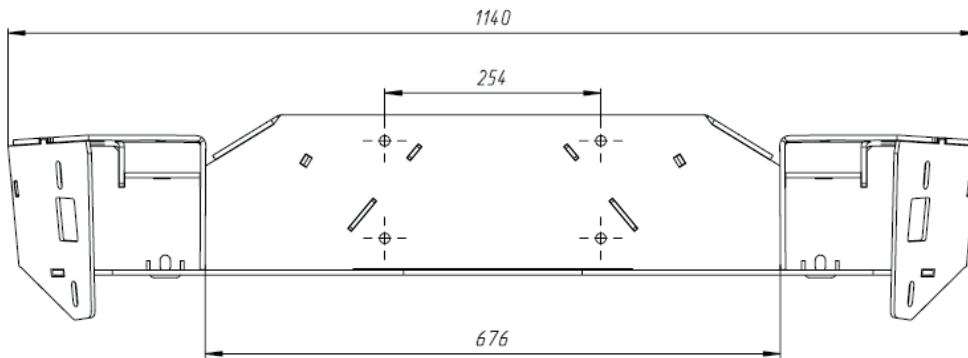

### Winch size limits:

L 670 x W 185 mm x H 260 mm

## LIGHTS

The bumper provides for the light mounting points.

### Overall dimensions of the lights under installation:

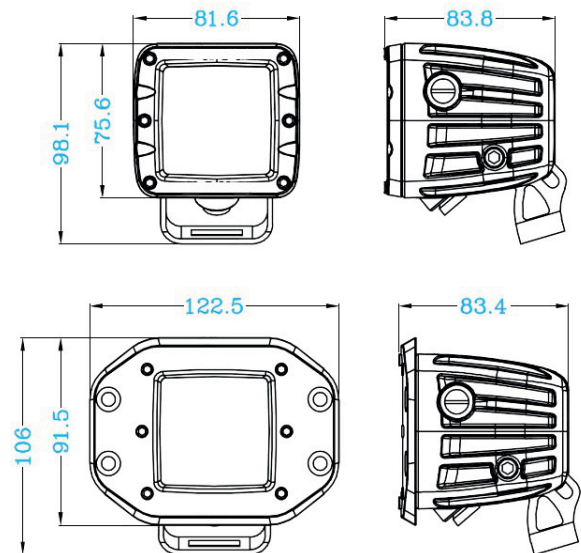

# PARTS LISTING

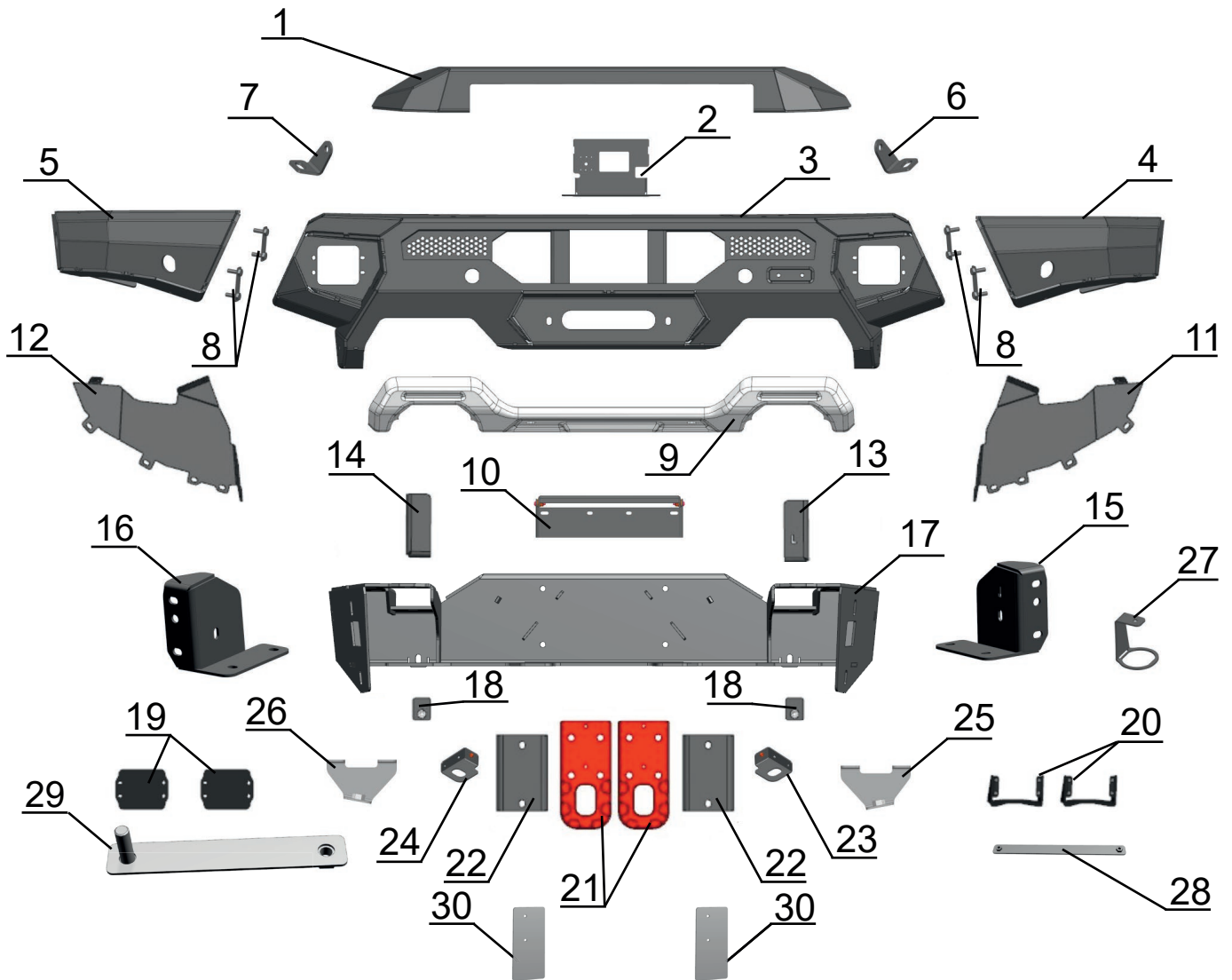

1. Lightbar cap.....	Qty 1	16. Reinforcing right bracket.....	Qty 1
2. Radar bracket.....	Qty 1	17. Winch mount bracket.....	Qty 1
3. Bumper body.....	Qty 1	18. Bash plate insert nut.....	Qty 2
4. Left end cap.....	Qty 1	19. Light cover.....	Qty 2
5. Right end cap.....	Qty 1	20. Light bracket.....	Qty 2
6. Lightbar left bracket.....	Qty 1	21. Recovery point.....	Qty 2
7. Lightbar right bracket.....	Qty 1	22. Recovery point bracket.....	Qty 2
8. End cap insert nut.....	Qty 4	23. Intercooler right bracket.....	Qty 1
9. Bash plate.....	Qty 1	24. Intercooler left bracket.....	Qty 1
10. License plate bracket.....	Qty 1	25. Skid plate left bracket.....	Qty 1
11. Left flap.....	Qty 1	26. Skid plate right bracket.....	Qty 1
12. Right flap.....	Qty 1	27. Wrench for mounting parking sensors.....	Qty 1
13. Additional left bracket.....	Qty 1	28. License plate insert nut.....	Qty 1
14. Additional right bracket.....	Qty 1	29. Bumper body insert nut.....	Qty 2
15. Reinforcing left bracket.....	Qty 1	30. Recovery point cover.....	Qty 2

# PARTS LISTING

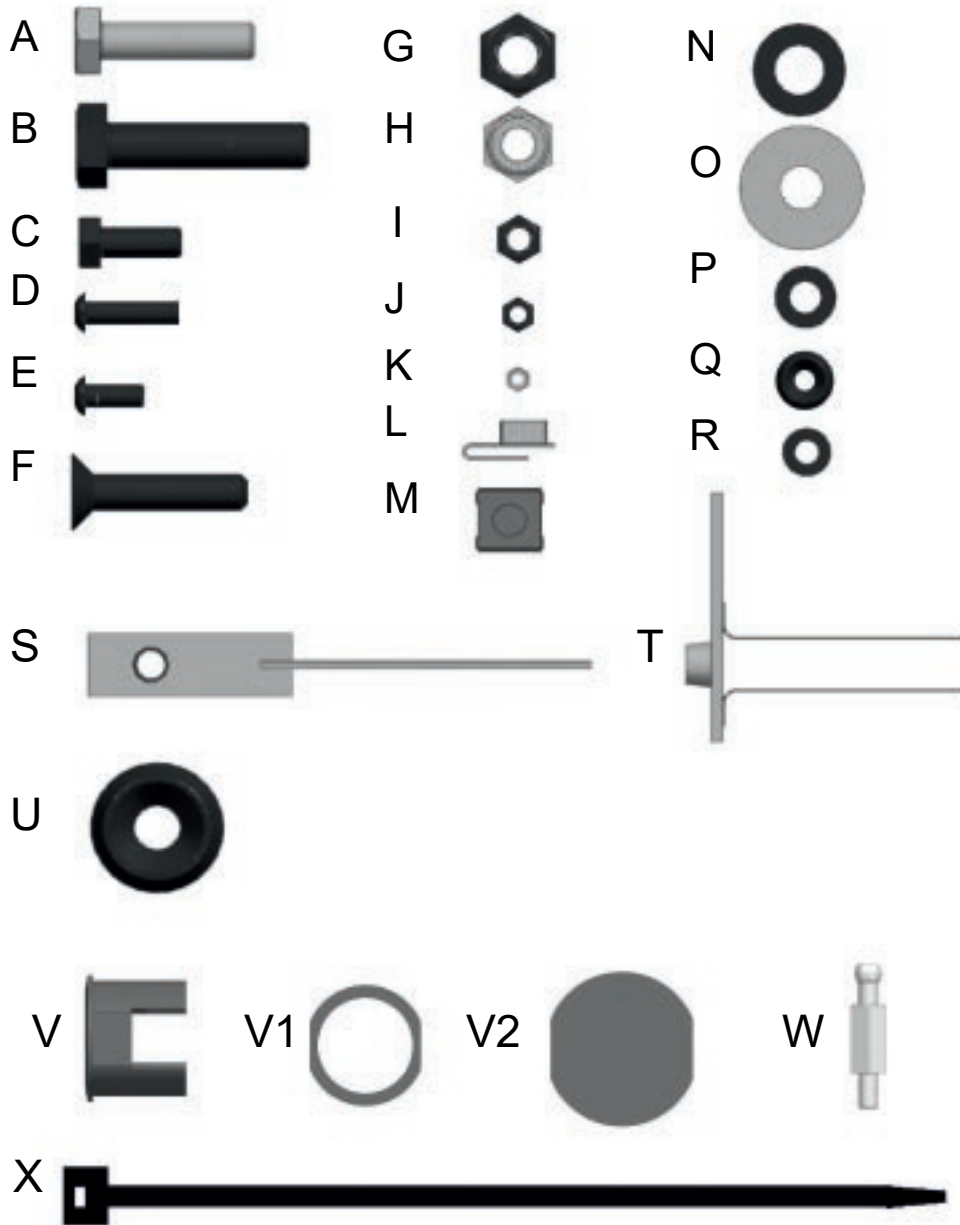

A. Bolt M10x35.....	Qty 8	N. Washer 12.....	Qty 18
B. Bolt M12x50.....	Qty 10	O. Penny washer 10.....	Qty 22
C. Bolt M8x20.....	Qty 10	P. Washer 8.....	Qty 12
D. Round-head screw M6x20.....	Qty 38	Q. Penny washer 6.....	Qty 16
E. Round-head screw M6x16.....	Qty 4	R. Washer 6.....	Qty 34
F. Countersunk-head screw M10x40.....	Qty 8	S. Insert nut M10 with cable.....	Qty 2
G. Nut M12.....	Qty 8	T. Insert nut M10 with cables.....	Qty 4
H. Nut M10.....	Qty 14	U. Countersunk washer.....	Qty 8
I. Nut M8.....	Qty 2	V. Parking sensor spacer.....	Qty 6
J. Nut M6.....	Qty 8	V1. Parking sensor nut.....	Qty 6
K. Nut M3.....	Qty 4	V2. Parking sensor cap.....	Qty 6
L. U-nut M6.....	Qty 16	W. Radar mounting pin.....	Qty 2
M. Cage nut M8.....	Qty 4	X. Cable tie.....	Qty 6

# INSTALLATION PROCEDURE

## Preparation for installation (steps 1-21)



Fig.1

1. Remove the plastic plug recovery point (fig.1). The mounting points are shown in the fig.2.



Fig.2

2. Unscrew 3 bolts (fig.2).

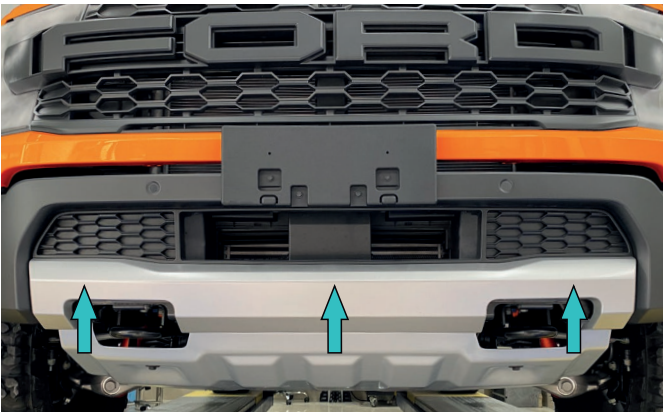

Fig.3

3. Remove the plastic cover (fig.3). The plastic cover attached to plastic clips.



Fig.4

4. Remove the plastic grille (fig.4). The mounting points are show in the fig.5.

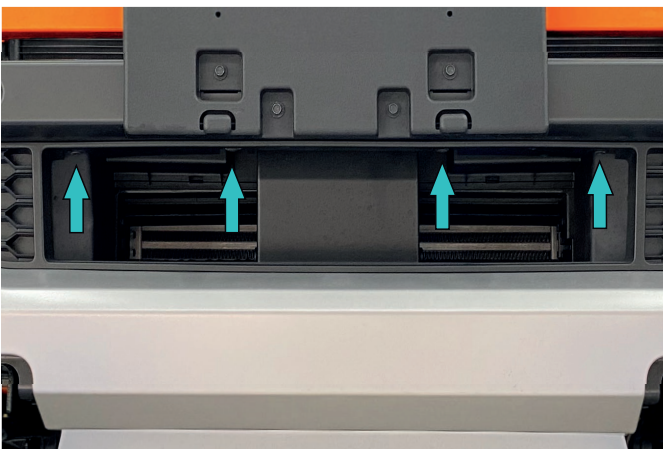

Fig.5

5. Unsrew 4 bolts (fig.5).

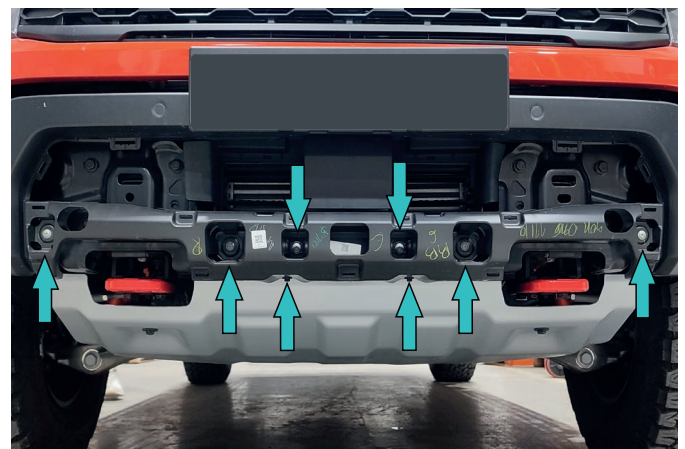

Fig.6

6. Unscrew all bolts of front bumper (fig.6).

# INSTALLATION PROCEDURE



Fig.7

7. Open the hood. Disconnect terminal “-” from the vehicle battery (fig.7).

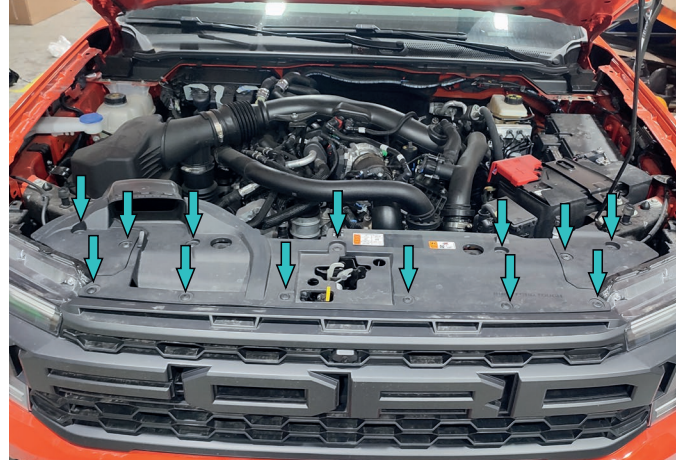

Fig.8

8. Release the phillips head clips to remove the top cover (fig.8).

**\*Set aside for re-use later on.**

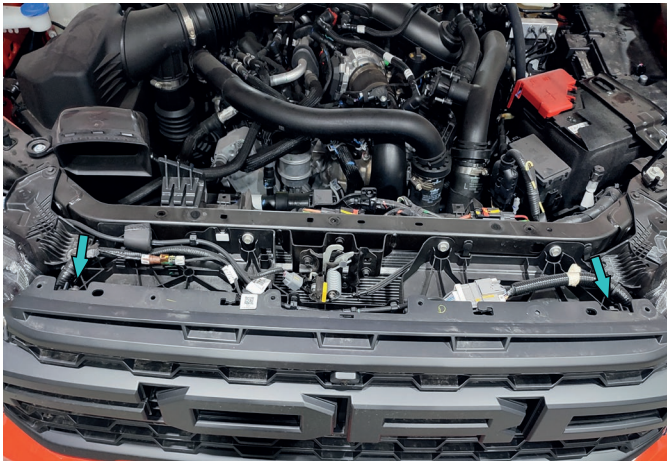

Fig.9

9. Unscrew factory bolts (fig.9).  
**\*Set aside for re-use later on.**

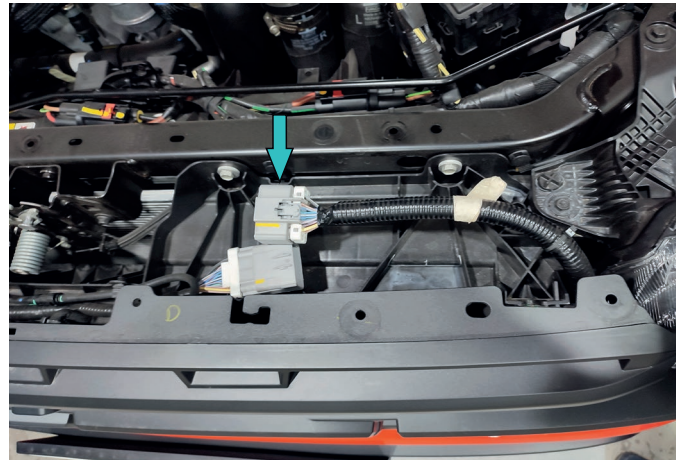

Fig.10

10. Disconnect the factory wiring plug (fig.10).



Fig.11

11. Remove the lower plastic pad radiator grille (fig.11).



Fig.12

12. Unscrew the lower radiator grille bolts (fig.12).



# INSTALLATION PROCEDURE

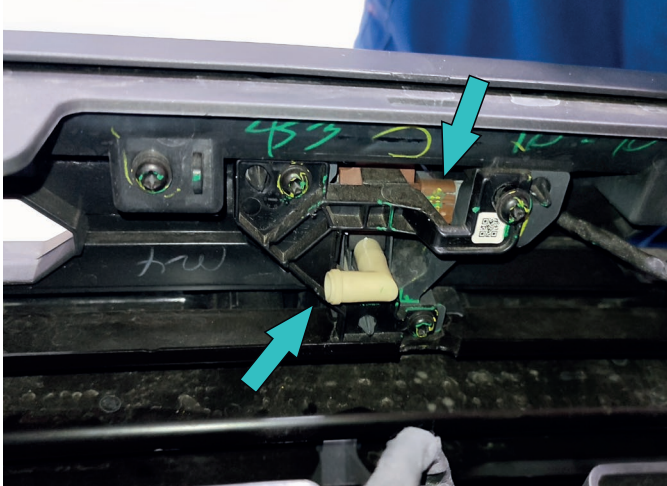

Fig.13

13. Disconnect the front camera washer tube and disconnect the front camera (fig.13).



Fig.14

14. Remove the radiator grille (fig.14).

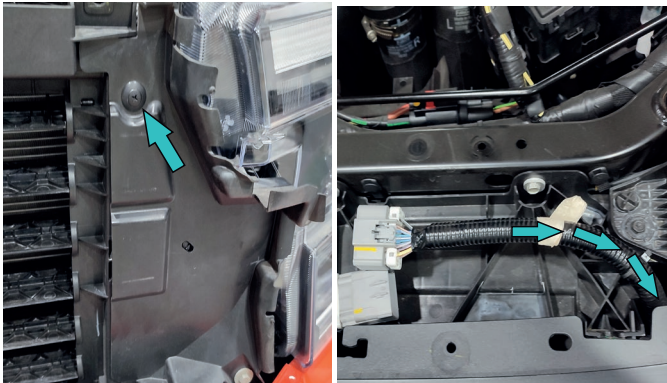

Fig.15

15. Remove the clip, unbend factory dust cover and pull-out factory wiring completely (fig.15).



Fig.16

16. Remove the front bumper (fig.16).

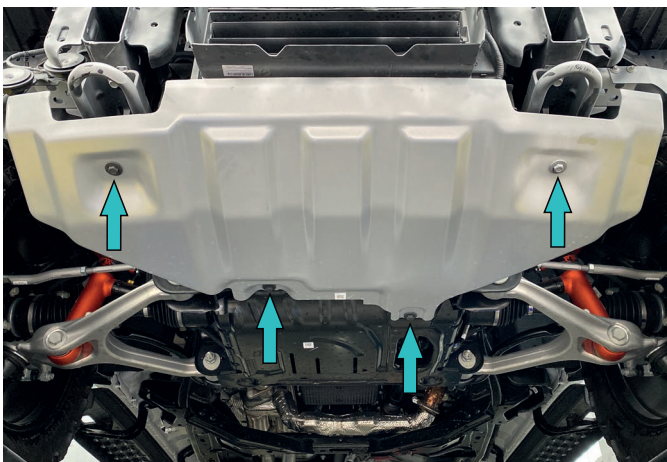

Fig.17

17. Unscrew factory bolts of engine skid plate. (fig.17)

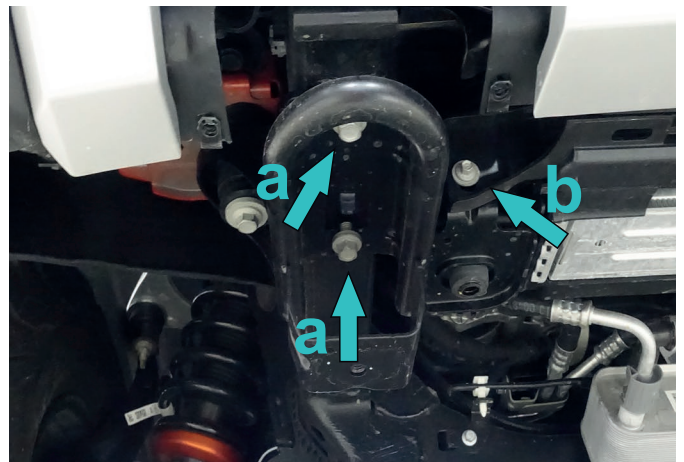

Fig.18

18. Unscrew (fig.18):  
a - 2 recovery point mounting bolts  
b - 1 intercooler mounting bolt.

# INSTALLATION PROCEDURE

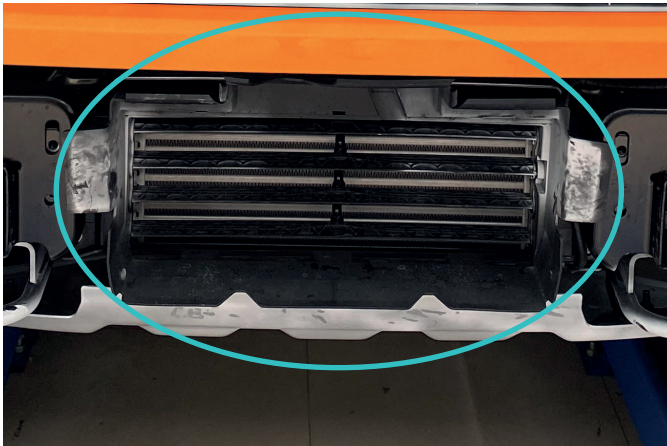

Fig.19

19. Remove the factory plastic deflector (fig.19).



Fig.20

20. Unscrew the nut and remove the factory plate with nuts (fig.20).

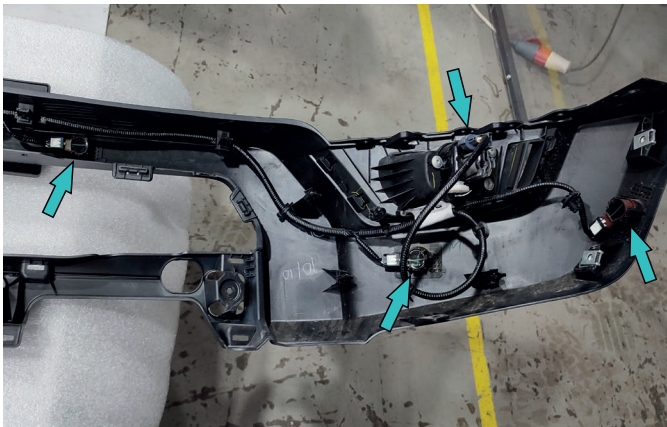

Fig.21

21. Disconnect electronic connectors on both sides of the factory bumper (fig.21).

## Recovery point installation procedure (steps 22-28)

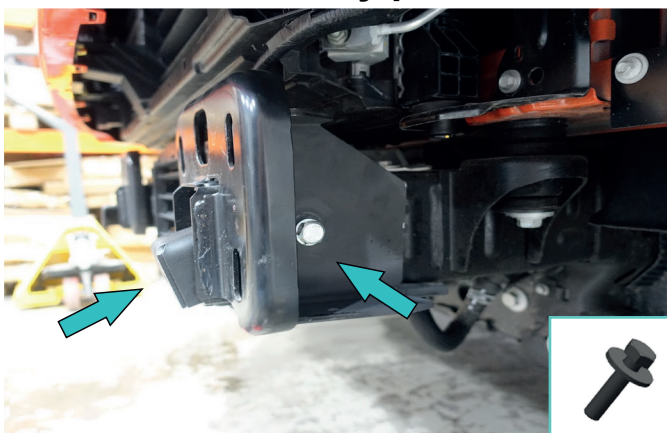

Fig.22

22. Install the reinforcing left bracket and additional left bracket (item 15, 13) on the left side of the vehicle using bolt M12x50 and washer 12 (item B, N) as shown in fig.22.

**\*Do not tighten yet.**

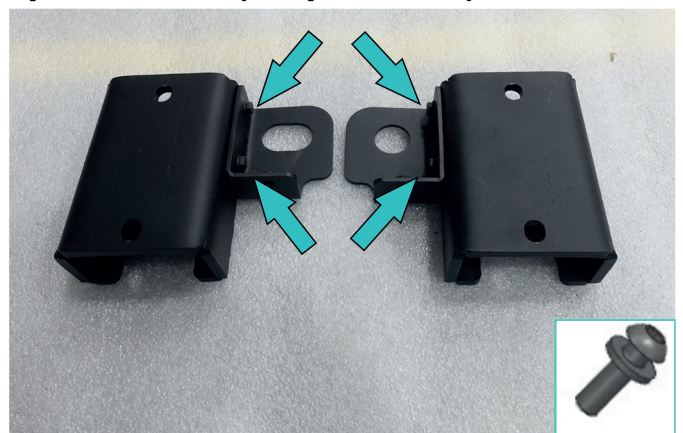

Fig.23

23. Install intercooler brackets (item 23, 24) on recovery point brackets (item 22) and fix them using screw M6x20 and washers 6 (item D, R) (fig.23).

**\*Tighten hardware after that.**

# INSTALLATION PROCEDURE

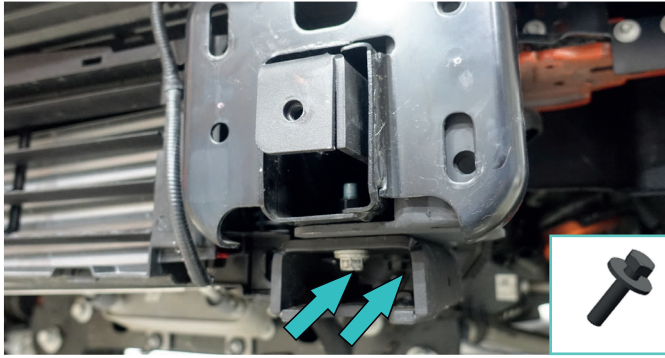

Fig.24

24. Install recovery point bracket (item 22) using factory bolts M12 as shown in fig.24.  
**\*Tighten hardware after that.**

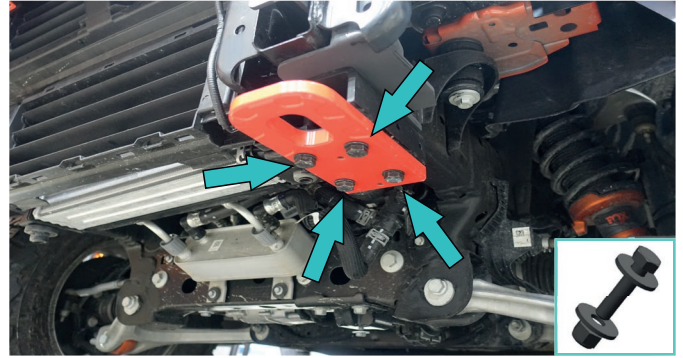

Fig.25

25. Install recovery point (item 21) on the recovery point bracket (item 22) and fix it using bolts M12x50, washers 12 and nuts M12 (item B, N, G) (fig.25).  
**\*Tighten hardware after that.**

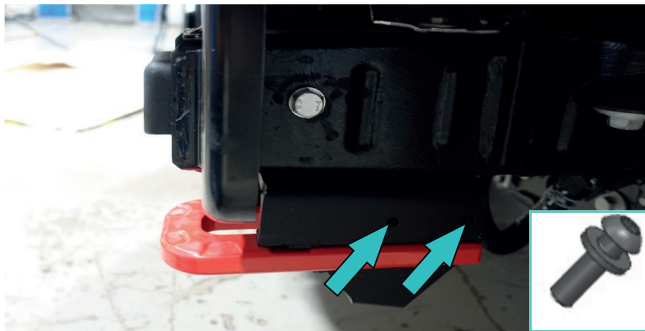

Fig.26

26. Install накладку петель (item 30) using screws M6x20, washer 6 (item D, R) (fig.26).

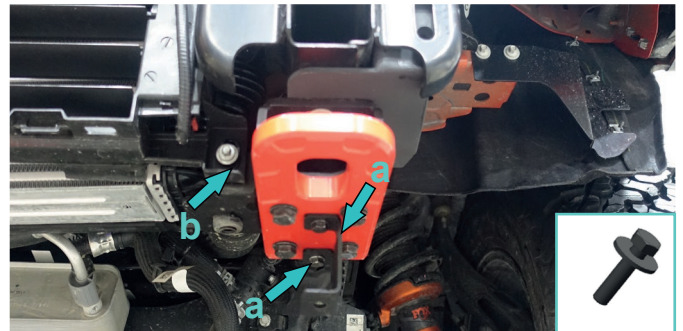

Fig.27

27. a) Install left bracket for skid plate (item 25) on the left side using bolts M8x20, washers 8 (item C, P).  
b) Fix factory bracket to intercooler left bracket (item 24) using factory bolt (fig.27).  
**\*Tighten hardware after that.**



Fig.28

28. Repeat the same steps 22-27 for the right side of the vehicle using items 16, 14, 24, 21, 22, 26, 30 (fig.28).

# INSTALLATION PROCEDURE

## Winch bracket installation procedure (steps 29-33)

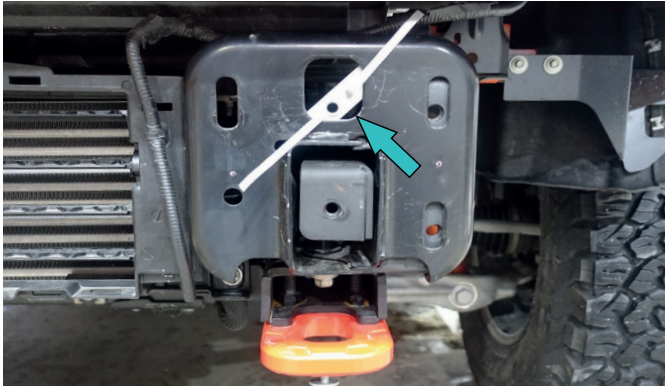

Fig.29

29. Install insert nut M10 with cables (item T) as show in fig.29.

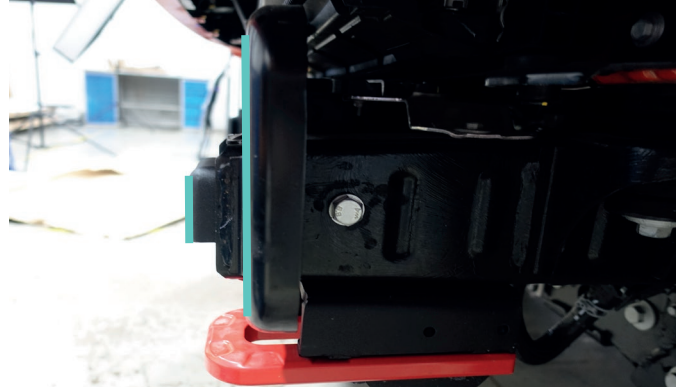

Fig.30

30. Align the additional bracket parallel to the frame flange (fig.30).



Fig.31

31. Repeat the same steps 29-30 on the right side of vehicle (fig.31).

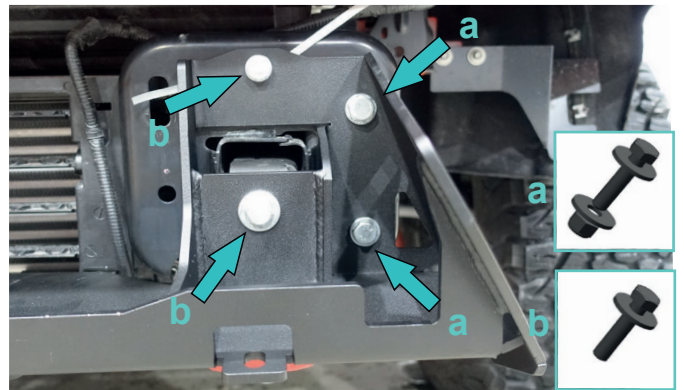

Fig.32

32. Install winch bracket (item 17) and fix it using:  
a) bolts M10x35, penny washers 10 and nuts M10 (item A, O, H);  
b) bolts M10x35 and penny washers 10 (item A, O) (fig.32).



Fig.33

33. Repeat the same step 32 to fix winch bracket on the right side (fig.33).

**\*Do not tighten yet.**

# INSTALLATION PROCEDURE



Fig.34



Fig.35

34. Center the winch bracket (item 17). Measure the distance from the corner of the headlight to the opposite corner of the winch bracket as shown in fig.34,35. The distances must be the same. **\*Tighten hardware after that.**

## Winch installation procedure (steps 35-36)

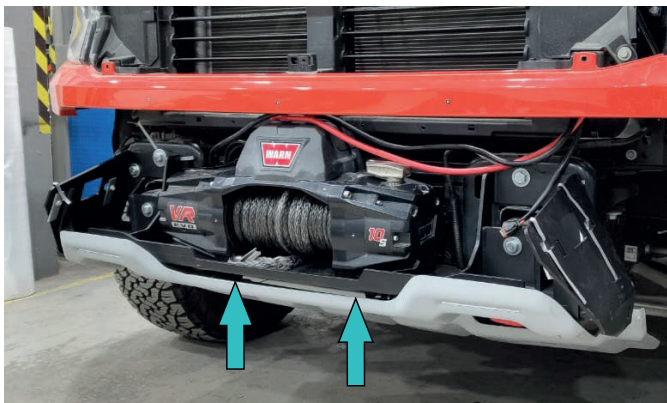

Fig.36

35. Install the winch and fix it using bolts and nuts that are included with the winch (fig.36).



Fig.37

36. Fix the factory wiring to the holes using cable ties (item X) (fig.37).

# INSTALLATION PROCEDURE

## Front bumper installation procedure (steps 37-80)

### Step 37 in case you have lightbar

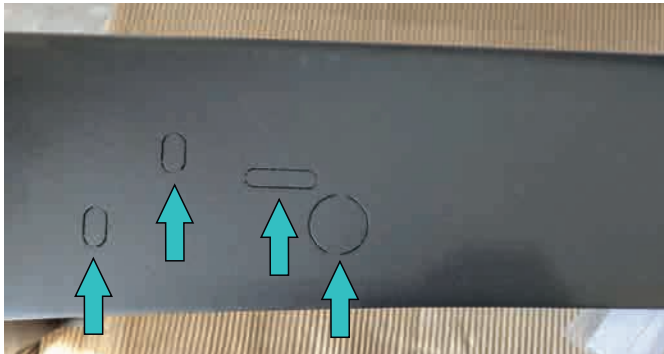

Fig.38

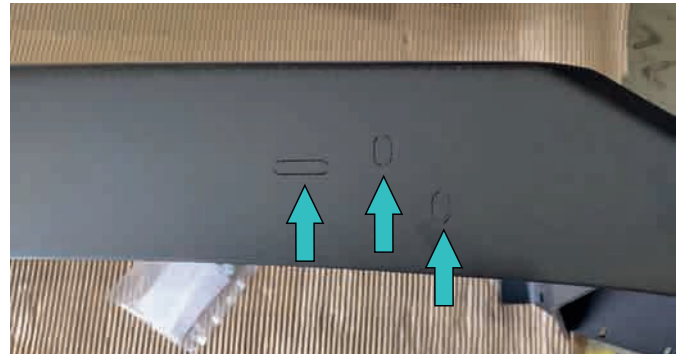

Fig.39

37. Hammer out the plugs for lightbar on the bumper body (fig.38,39).

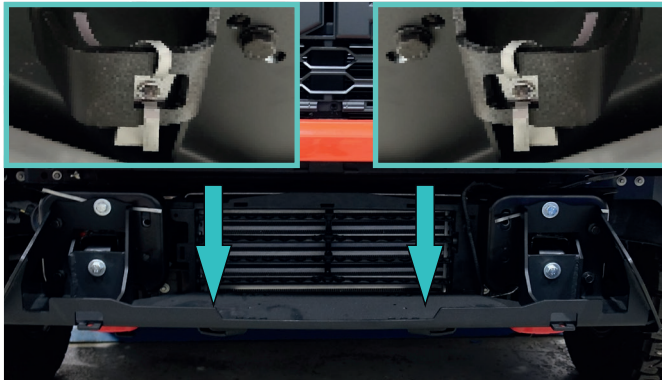

Fig.40

38. Install insert nuts M10 with cables (item T) (fig.40).

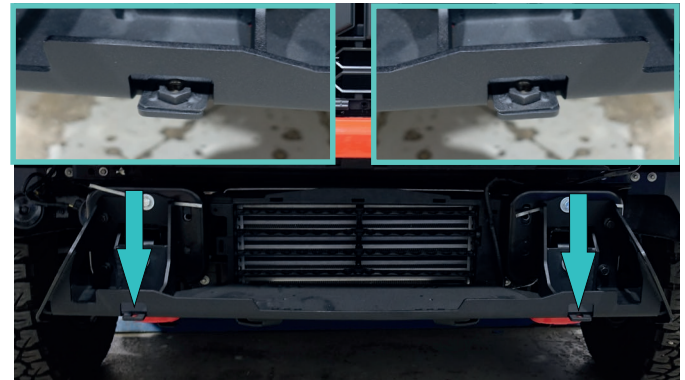

Fig.41

39. Put 2 insert nuts (item 18) on winch bracket (item 17) as shown in fig.41.



Fig.42

40. Install bash plate (item 9) using countersunk-head screws M10x40 and countersunk washers (item F, U) (fig.42).  
**\*Do not tighten yet.**

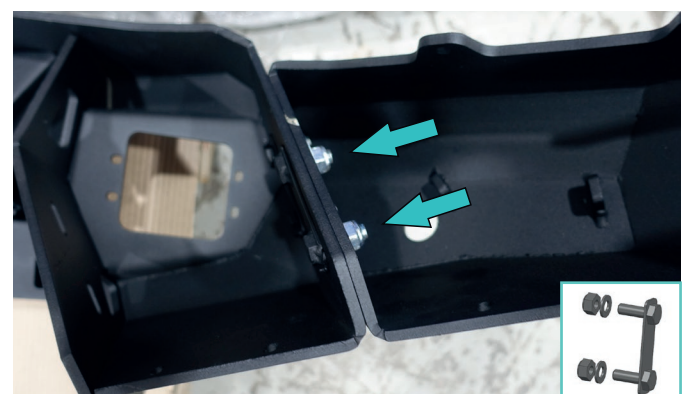

Fig.43

41. Fix the end caps (item 4, 5) to the bumper body (item 3) using insert nuts (item 8), penny washers 10 and nuts M10 (item O, H) (fig.43).  
**\*Tighten hardware after that.**

# INSTALLATION PROCEDURE

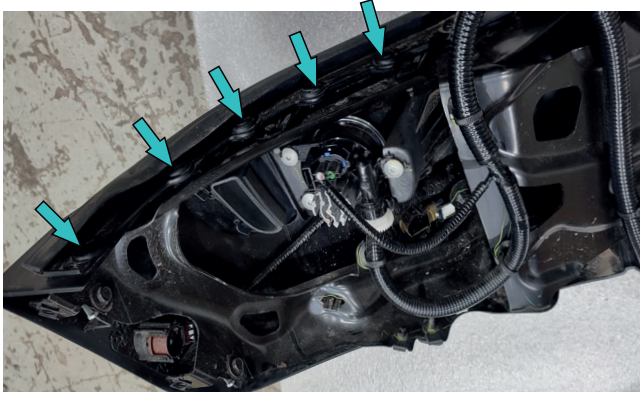

Fig.44

42. Unscrew and remove the gasket on both sides of the factory bumper (fig.44).



Fig.45

43. Install factory gasket using screws M6x20, penny washers 6 and nuts M6 (item D, Q, J) on both sides of the end caps (fig.45).



Fig.46

44. Hammer out all plugs of the RIVAL bumper. Install the spacers (item V) in parking sensors holes (fig.46) and fix them using nuts (item V1) as shown in fig.47. Use the parking sensor wrench (item 27).

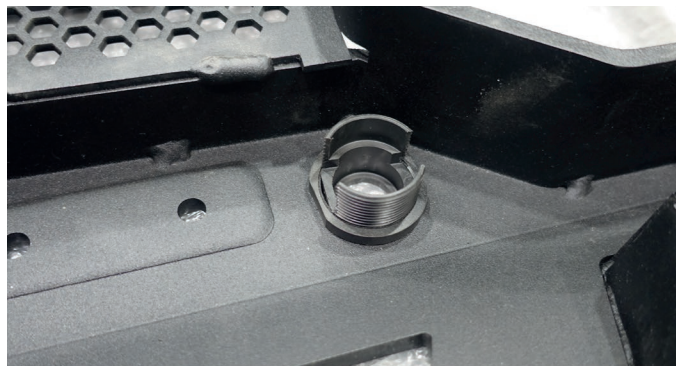

Fig.47



Fig.48

45. Remove the factory parking sensor wiring (fig.48).



Fig.49

46. Install the factory wiring, fix it to the holes using cable ties (item X) (fig.49).  
**\*Tighten hardware after that.**

# INSTALLATION PROCEDURE

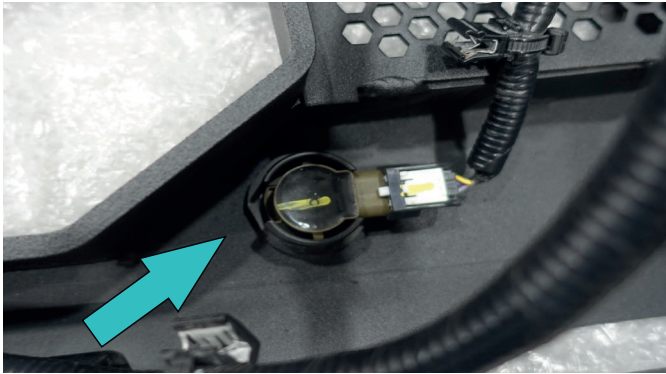

Fig.50

47. Install the factory parking sensors in the bumper (fig.50).

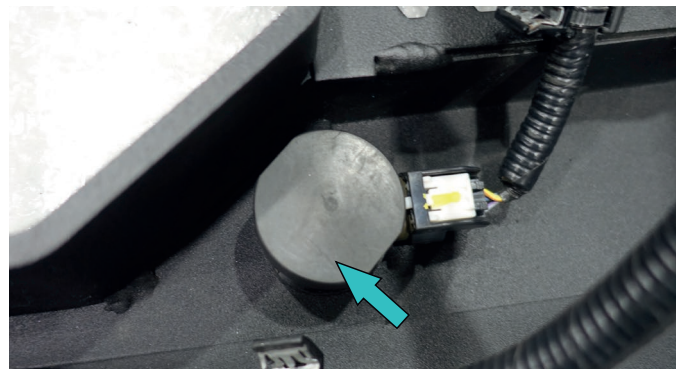

Fig.51

48. Fix the parking sensors using the parking sensor cap (item V2) (fig.51).



Fig.52

49. Unscrew and remove radar on factory bumper (fig.52).

**\*Set aside for re-use later on.**

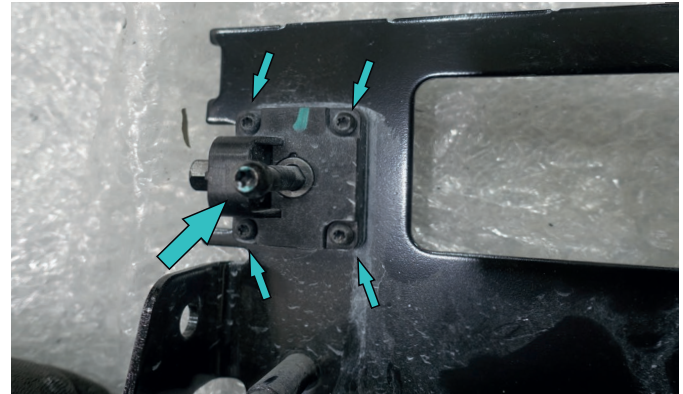

Fig.53

50. Undo the factory adjusting screw, then remove the adjusting mechanism. (fig.53).

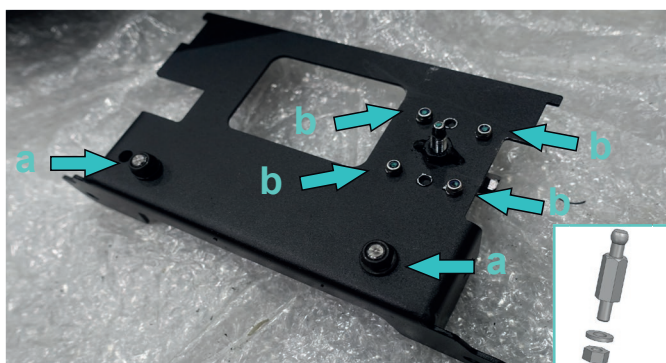

Fig.54

51. a) Install radar mounting pins (item W) to the radar bracket (item 2) using washer 6 and nut M6 (item R, J) (fig.54).

b) Fix the factory adjusting mechanism using factory screws and nuts (item K) (fig.54).

c) After that, screw the factory adjusting screw from step 50.

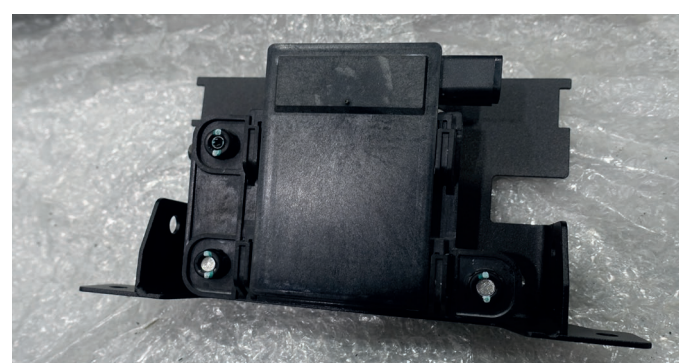

Fig.55

52. Fix the factory radar on the radar bracket (item 2) (fig.55).



# INSTALLATION PROCEDURE

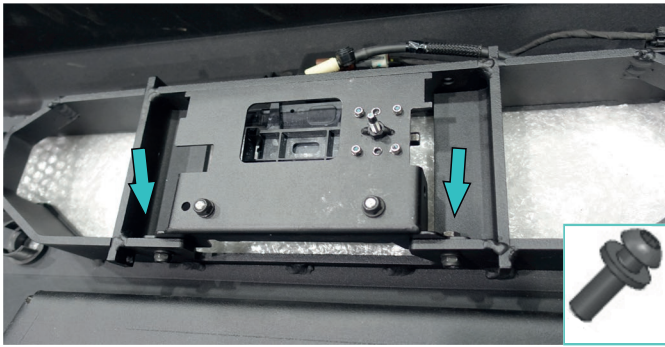

Fig.56

53. Install the radar bracket (complete with factory radar) (item 2) on the bumper body (item 3) using bolts M6x16 with washers 6 (item E, R) (fig.56).

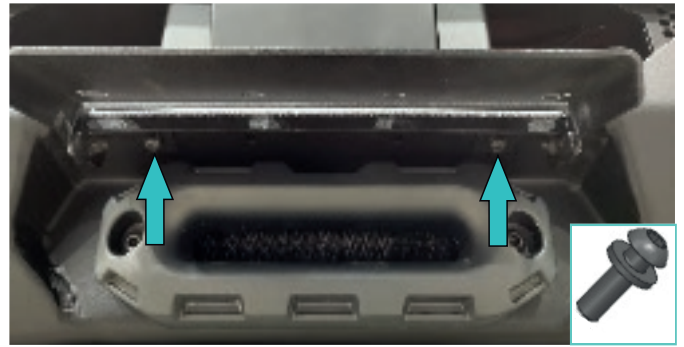

Fig.57

54. Install the license plate bracket (item 10) using screws M6x16, washers 6 and insert nut (item E, R, 28) (fig.57).

**\*Tighten hardware after that.**



Fig.58

55. Install the bumper on the winch bracket as shown in fig.58.

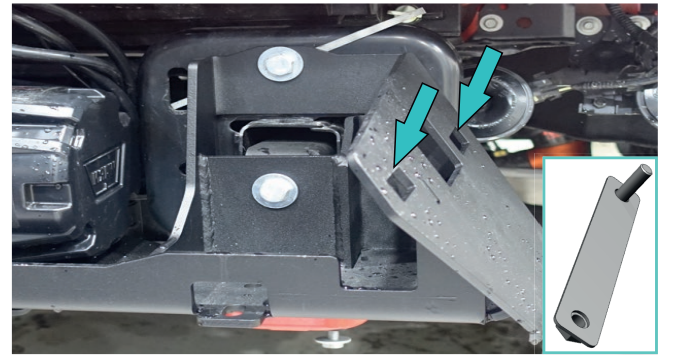

Fig.59

56. Through the bumper body winch access hole install insert nut (item 29) to the winch bracket as shown in fig.59.



Fig.60

57. Install the bumper using countersunk-head screws M10x40 and countersunk washers (item F, U) on both sides of the bumper (fig.60).

**\*Do not tighten yet.**

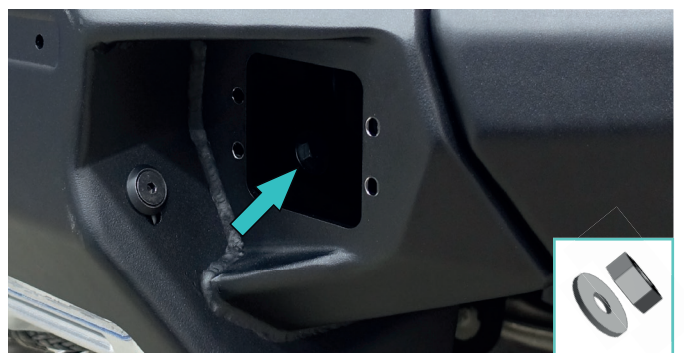

Fig.61

58. Install nut M10 with penny washer 10 (item H, O) on both sides of the bumper (fig.61).

**\*Do not tighten yet.**

# INSTALLATION PROCEDURE

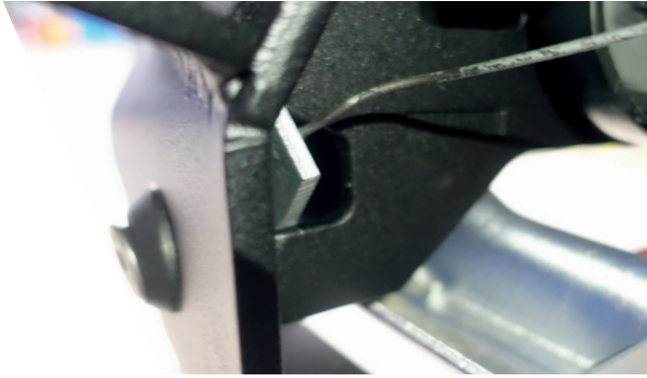

Fig.62



Fig.63

59. Install insert nuts M10 with cable (item S) to the winch mount bracket (item 17) as shown in fig.62 and fix it using countersunk-heads screw M10x40 and countersunk washers (item F, U) on both sides of the bumper (fig.63).

**\*Do not tighten yet.**



Fig.64

60. Align the edge of the bumper end cap with the factory fender on the both side of the bumper as shown in fig.64.



Fig.65

61. Tighten hardware using the screws and bolts from steps 57, 58, 59.

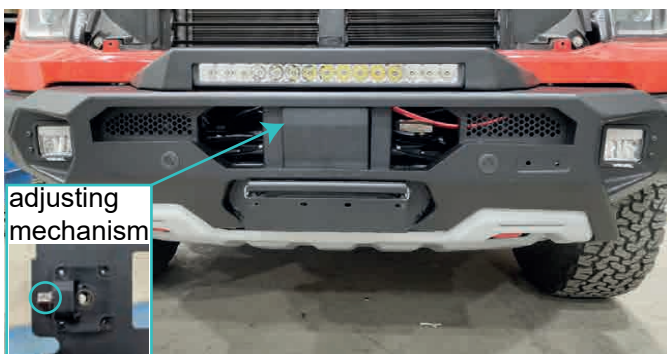

Fig.66

62. Align the radar position perpendicular to the road using the adjustment mechanism as it was on the factory bumper. Install the factory radar cap (fig.66).

# INSTALLATION PROCEDURE

## Steps 63-65 in case you have lightbar



Fig.67

63. Mount the brackets (item 6, 7) to lightbar (item 1) and fix them using screws that are included with lightbar (fig.67).

**\*Do not tighten yet.**



Fig.68

64. Install lightbar on the bumper as shown in fig.68 and fix it using bolts M8x20, washers 8 and nuts M8 (item C, P, I).

**\*Tighten hardware after that.**

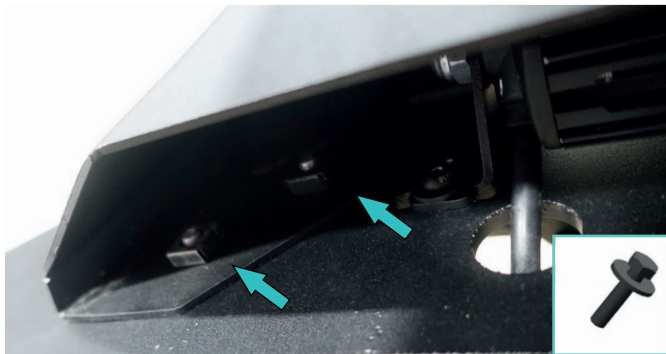

Fig.69

65. Install the cage nuts (item M) on lightbar cap (item 1) as shown in fig.69 and fix lightbar cap on both sides of the bumper using bolts M8x20 and washers 8 (item C, P) (fig.70).

**\*Tighten hardware after that.**



Fig.70



Fig.71

66. Fix your aftermarket LED cubic lights to the brackets (item 20). These brackets are not compatible with flush mount LED lights (part number 2D.0041.1, purchased separately) (fig.71).

**\*Tighten hardware after that.**



Fig.72

67. Install LED lights or LED light caps (item 19) using screws M6x20, washers 6 (item D, R) and LED light brackets (item 20) (fig.72).

**\*Tighten hardware after that.**

# INSTALLATION PROCEDURE



Fig.73

68. In case if you have LED light, connect LED light plug to factory wiring.

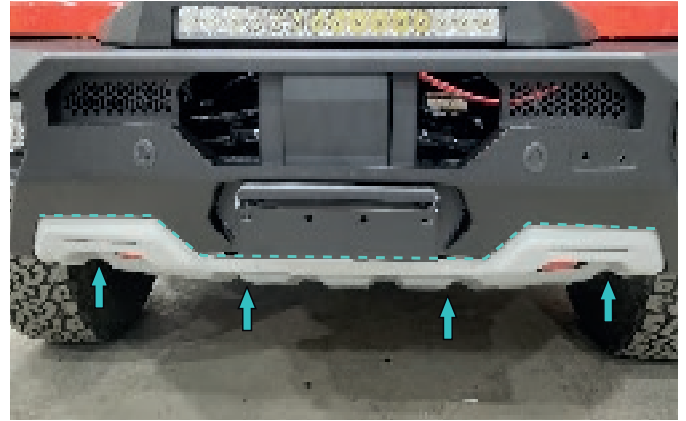

Fig.74

69. Align the edge of bash plate with the lower edge of bumper as shown in fig 74.

**\*Tighten hardware after that.**

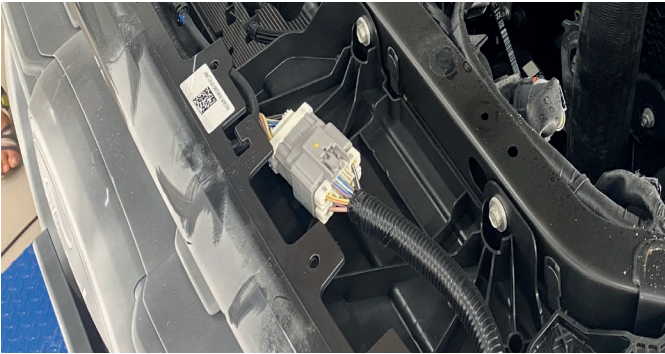

Fig.75

70. Connect the factory wiring plug (fig.75).



Fig.76

71. Install engine skid plate and tighten hardware using factory bolts (fig.76).



Fig.77

72. Install the fairlead on the bumper, in case if you installed the winch, the hardware supplied with a fairlead (fig.77).

**\*Tighten hardware after that.**

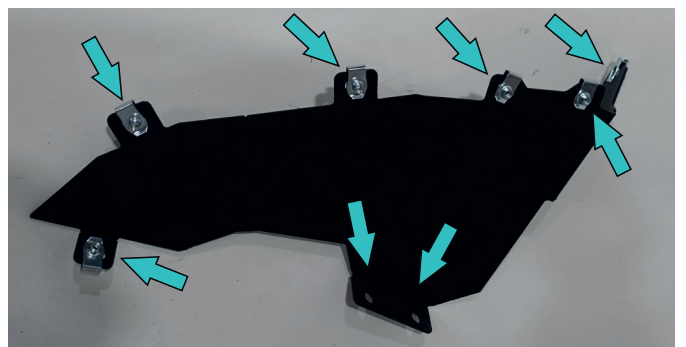

Fig.78

73. Fit U-nuts M6 (item L) on flaps (item 11, 12) (fig.78).

# INSTALLATION PROCEDURE

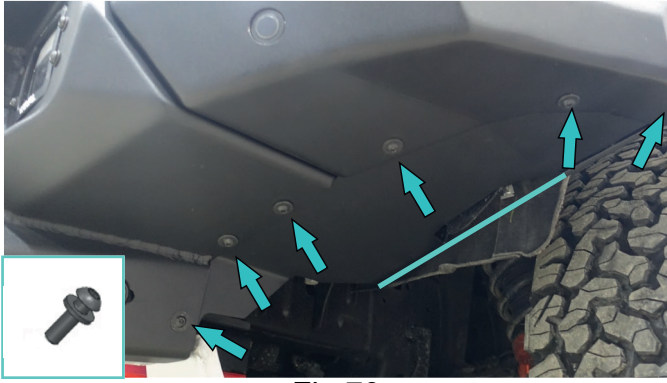

Fig.79

74. Install flaps (item 11, 12) using screws M6x20, washers 6 (item D, R) to the bumper body (6 мест) on each side. Push the flap to plastic fender and mark future cutting line. Cut plastic fender following marked cutting line using jig-saw or shears (fig.79).

**\*Tighten hardware after that.**



Fig.80

75. Mark and drill 2 holes in plastic fender according with holes in flap on each side of the vehicle. Fix flaps and fenders using screws M6x20, penny washers 6 (item D, Q) (fig.80).

**\*Tighten hardware after that.**

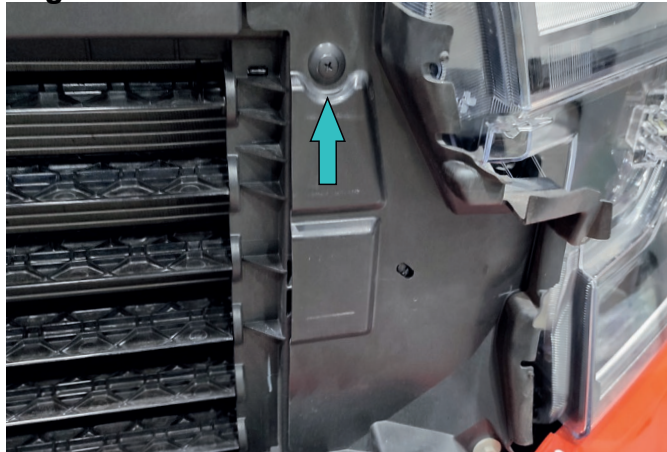

Fig.81

76. Install the factory clip from step 15 (fig.81).

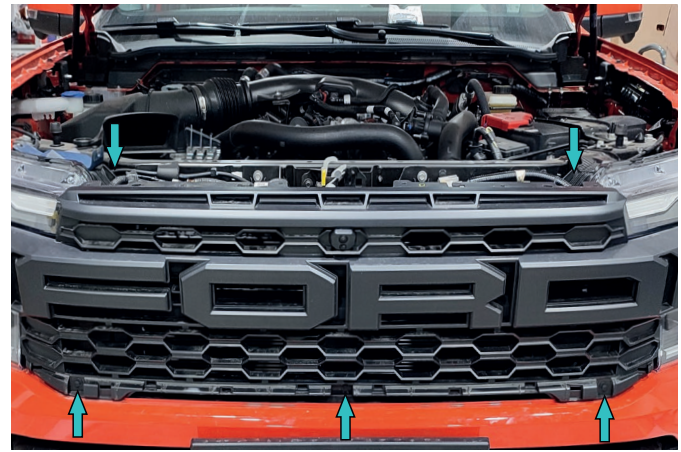

Fig.82

77. Install factory radiator grille and fix in using factory bolts. Connect the front camera washer tube and Connect the front camera (fig.82).



Fig.83

78. Install the lower plastic pad radiator grille (fig.83).

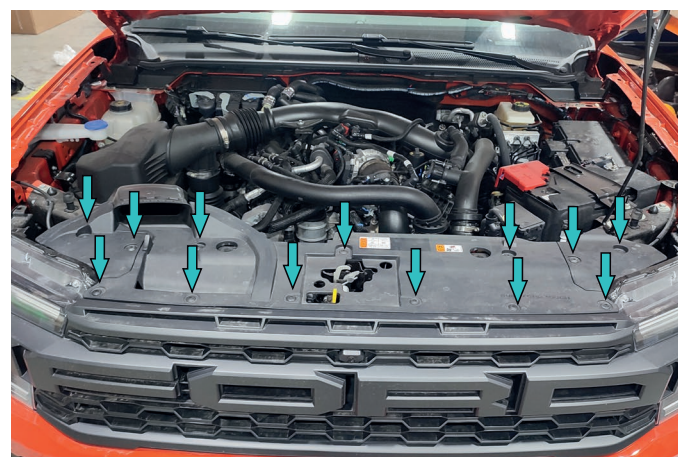

Fig.84

79. Install the factory plastic pad and fix it using factory clips (fig.84).

# INSTALLATION PROCEDURE

---



Fig.85

80. Connect terminal “-” on the battery (fig.85).

# INSTALLATION PROCEDURE

---

Before operating a vehicle fitted with RIVAL Bumper 2D.1813.1-NL:

- make sure all fittings are tightened
- check winch operation
- check that all electrical wiring is attached to the lights

