

PRODUCT: ENGINE SKID PLATE

APPLICATION: DODGE RAM 1500 (2018-Present)  
DODGE RAM 1500 TRX (2021-Present)

PART NO: 2333.1504.1.6



## CAUTION!

To reduce the risk of serious injury or damage to property: Before you start installing and using this product, read the full instructions, pay special attention to the conditions of safe use and recommendations for installation! When installing or maintaining this product, it is necessary to use protective goggles. Check the integrity of the structure and the moment the fastening is tightened every 250 miles (400 kms) of mileage. Do not use this product if there is damage to the structure or fasteners!

## NOTICE

Skid plate is an additional protection, but it can not guarantee to protect against all possible damage in collisions. When driving, be careful of objects and terrain that may damage sensitive parts of the vehicle.

# ENGINE SKID PLATE

**RIVAL**

Part number: 2333.1504.1.6



Suited to vehicle: Dodge RAM 1500 V-5.7, 5.7 Hybrid, 3.0D; AT; 4WD (2018-Present);  
Dodge RAM 1500 TRX V-6.2; AT; 4WD (2021-Present)

Material: Aluminum



## SAFETY NOTICE

- \* The RIVAL skid plate is designed to complement the use and design of the specified vehicle under conditions specified by the vehicle manufacturer.
- \* While driving the vehicle at any speed, collision with any other vehicle, animal or object must always be avoided.
- \* Following any collision with any other vehicle, animal or object, the RIVAL skid plate and the vehicle must be inspected by a specialized or suitably qualified vehicle repairer for possible damage to the components and assemblies in order to confirm suitability for further use of the vehicle.
- \* It is strongly recommended that you do not operate a vehicle with a damaged skid plate or its components. In the case of damage, please contact the nearest RIVAL dealer. Vehicle, or where the skid plate has been damaged, is extremely dangerous and must be avoided at all cost.

## INSTALLATION NOTICE

- \* The RIVAL skid plate must be mounted and affixed to the vehicle according to this installation manual.
- \* Personal safety during the installation process must be adhered to at all times.
- \* Do not install this skid plate on vehicle models other than those allowed in this manual.
- \* Estimated time for installation: 1 hour.

## REQUIRED TOOLS

- \* Basic tool kit
- \* Torque wrench

## TORQUE SETTING

- \* M10 - 47 N·m (34.7 lb/ft)

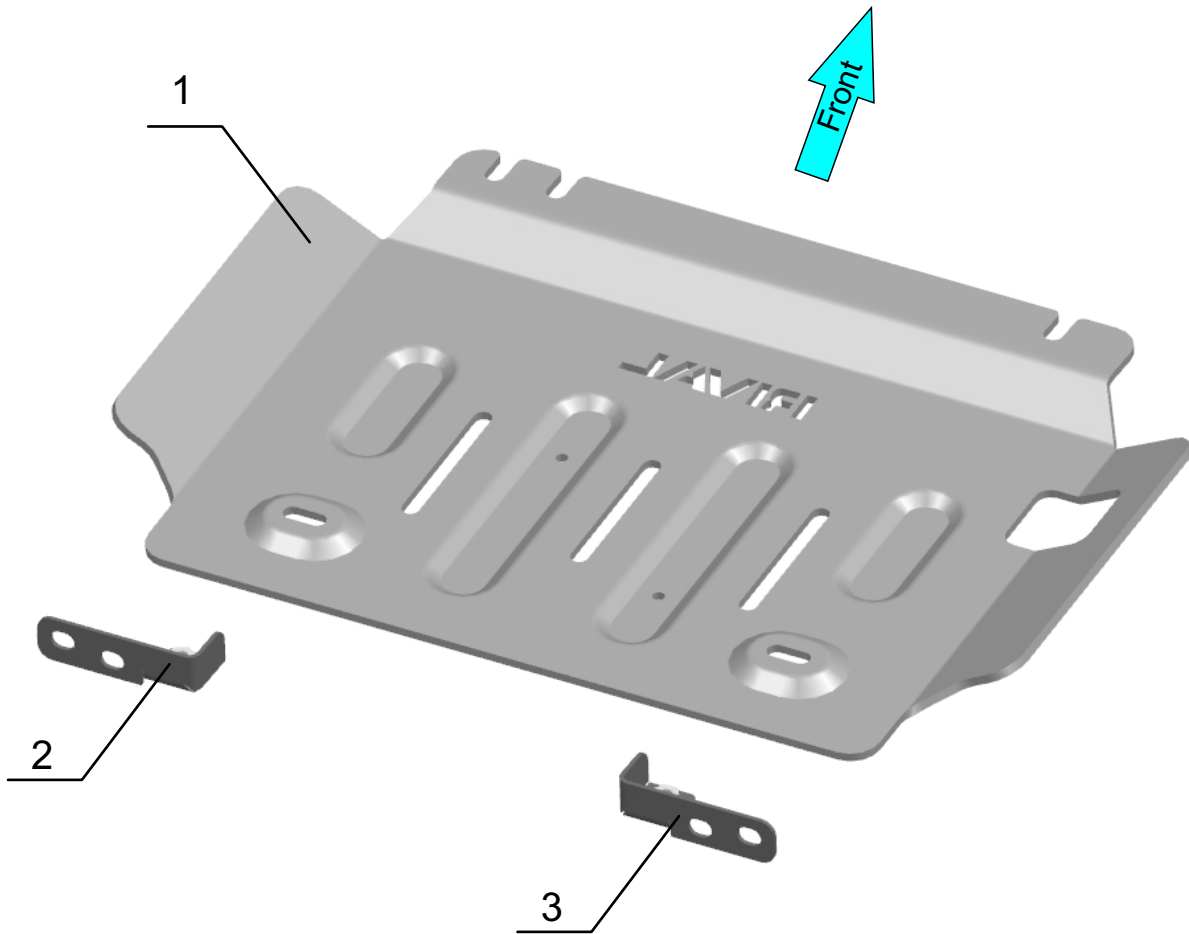

- 1. Engine skid plate.....Qty 1
- 2. Left bracket.....Qty 1
- 3. Right bracket.....Qty 1

# PARTS LISTING

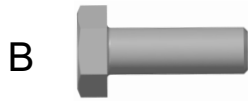

- A. Insert nut M10x65x20.....Qty 1
- B. Bolt M10x30.....Qty 4
- C. Penny washer M10.....Qty 4

# INSTALLATION PROCEDURE

**RIVAL**

\*If equipped, remove factory skid plate or any other aftermarket skid plate.

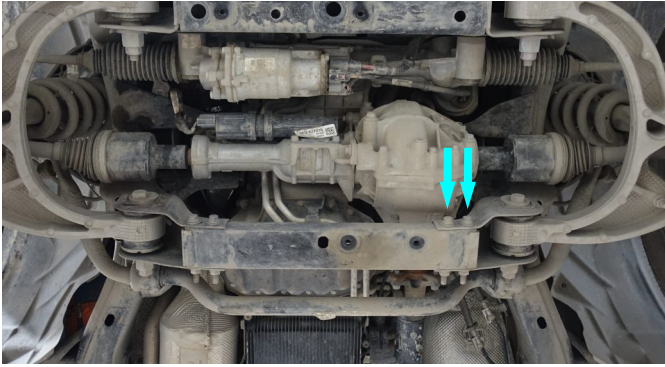

Fig. 1

1. Unscrew two factory bolts from car frame on the left side of the vehicle (fig.1).



Fig. 2

2. Install left bracket (item 2) as shown in fig.2 using factory bolts and nuts from step 1.  
**\*Tighten hardware after that.**

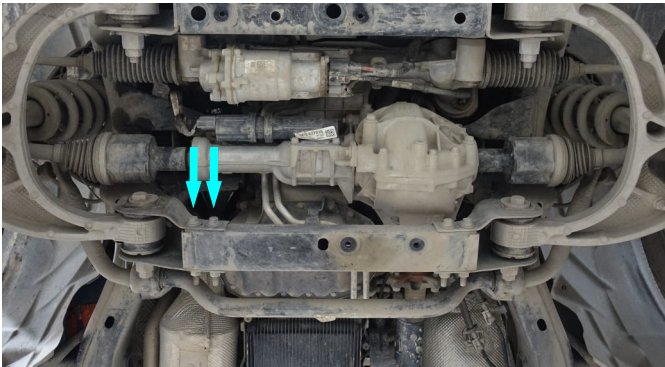

Fig. 3

3. Unscrew two factory bolts from car frame on the right side of the vehicle (fig.3).



Fig. 4

4. Install right bracket (item 3) as shown in fig.4 using factory bolts and nuts from step 3.  
**\*Tighten hardware after that.**

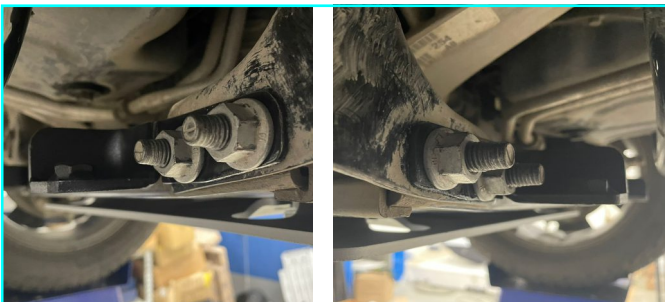

Fig. 5

5. If you plan to install RIVAL gearbox skid plate (2333.1505.1.6), then additionally install left bracket (item 2) and right bracket (item 3) from RIVAL gearbox skid plate (2333.1505.1.6) (fig.5). After that fix them using factory bolts and nuts from steps 1 and 3.



# INSTALLATION PROCEDURE

# RIVAL

If the RIVAL radiator skid plate (2333.1502.1.6/2333.1503.1.6) is not installed (steps 6-8).

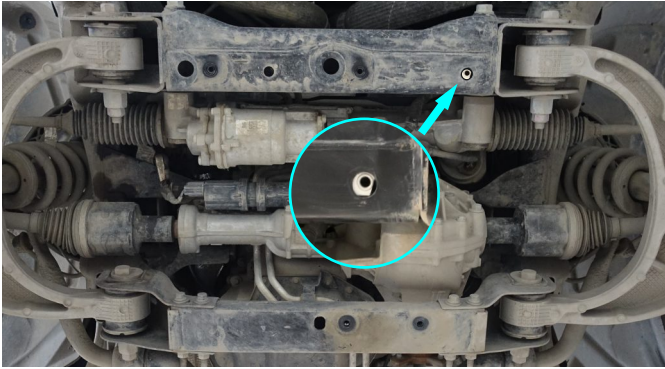

Fig. 6

6. Install insert nut M10x65x20 (item A) as shown in fig.6.

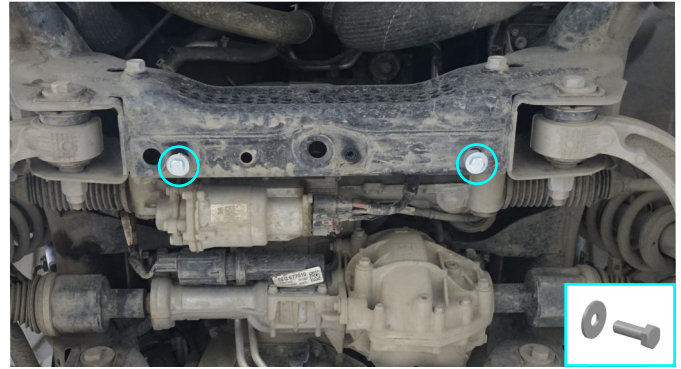

Fig. 7

7. Loosely insert supplied bolts M10x30 with penny washers M10 (items B, C) to insert nut M10x65x20 from step 6 and to factory thread hole as shown in fig.7.

**\*Do not tighten yet.**



Fig. 8

8. Slide front part of engine skid plate (item 1) under previously installed bolts M10x30 from step 7 and fix it using bolts M10x30 and penny washers M10 (items B, C) (fig.8).

**\*Once all bolts are inserted, tighten all previously installed hardware.**

If the RIVAL radiator skid plate (2333.1502.1.6/2333.1503.1.6) is installed (steps 9-10).



Fig. 9

9. Loosen 4 bolts on RIVAL radiator skid plate (fig.9).



Fig. 10

10. Slide front part of engine skid plate (item 1) under RIVAL radiator skid plate as shown in fig.10. After that fix it using bolts M10x30 and penny washers M10 (items B, C).

**\*Once all bolts are inserted, tighten all previously installed hardware.**

# INSTALLATION PROCEDURE

**RIVAL**

Installation procedure for RAM TRX with factory radiator skid plate (steps 11-12).



Fig. 11

11. Loosen four factory bolts (fig.11).



Fig. 12

12. Slide front part of engine skid plate under factory radiator skid plate as shown in fig.12. After that fix it using bolts M10x30 and penny washers M10 (items B, C).

**\*Once all bolts are inserted, tighten all previously installed hardware.**

Before operating a vehicle fitted with RIVAL Skid Plate:

- make sure all fittings are tightened;
- ensure the integrity of the structure and its components.

